

5 ESSENTIAL HINTS TO IMPROVE

Millimeter-wave Network Analysis

Contents

5 Essential Hints to Improve Millimeter-wave Network Analysis



Ensure Accurate,
Repeatable Results

[Go to Hint 1 >](#)



Calibrate for Better
Accuracy

[Go to Hint 2 >](#)



Accelerate Complex
Test Plans

[Go to Hint 3 >](#)



Simplify Measurement
Configuration

[Go to Hint 4 >](#)



Reduce Your Total Cost
of Test

[Go to Hint 5 >](#)

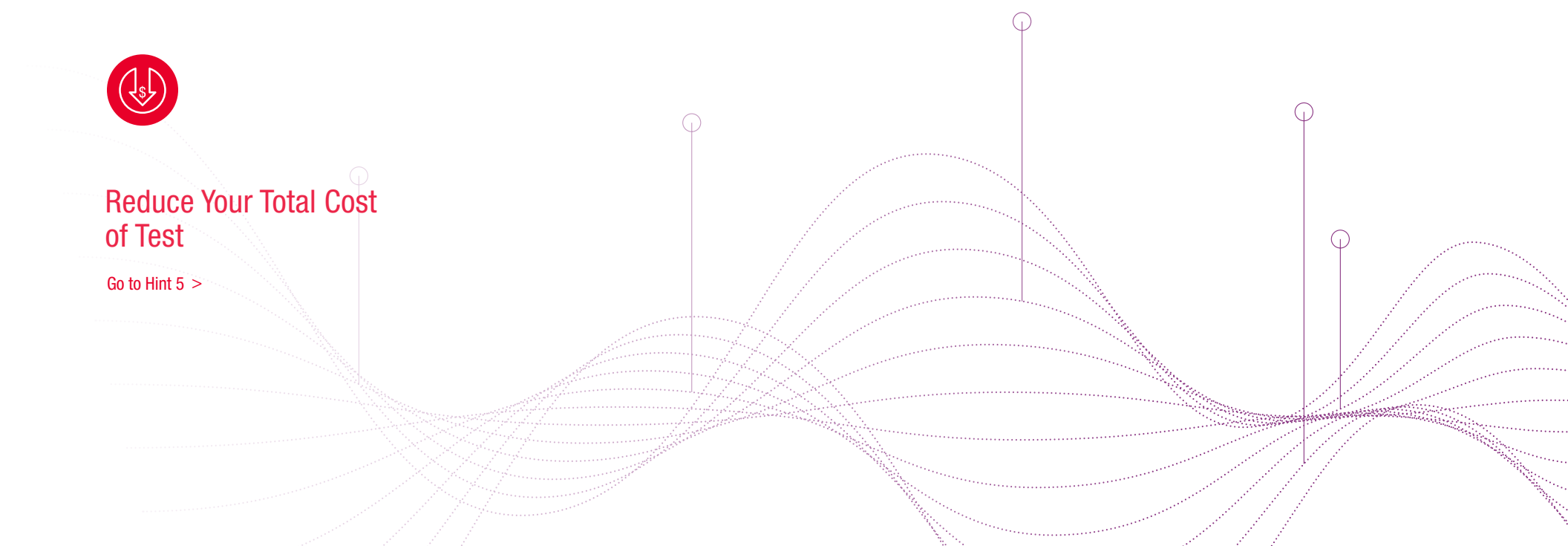



HINT 1

Ensure Accurate, Repeatable Results

HINT 1 Ensure Accurate, Repeatable Results

Gain Confidence With an Off-the-Shelf Solution

Assembling a “roll your own” millimeter-wave network analyzer can be challenging and time-consuming. Worse, there are no guaranteed specifications for stability or accuracy.

The better alternative is a preconfigured solution that includes a two- or four-port network analyzer along with the necessary millimeter-wave cabling, frequency extenders and test-set controller. With the N5290/91A solutions, you can select either a PNA or PNA-X network analyzer with maximum frequency of 26.5 GHz or 67 GHz. Our [configuration guide](#) describes the full range of choices.

The result is a broadband millimeter-wave solution that enhances device characterization and modeling for on-wafer and connectorized measurements. To ensure accurate and repeatable on-wafer results, the N5290/91A solution is also compatible with the [wafer-level measurement solution](#) (WMS) created by Keysight and solution-partner Cascade Microtech.

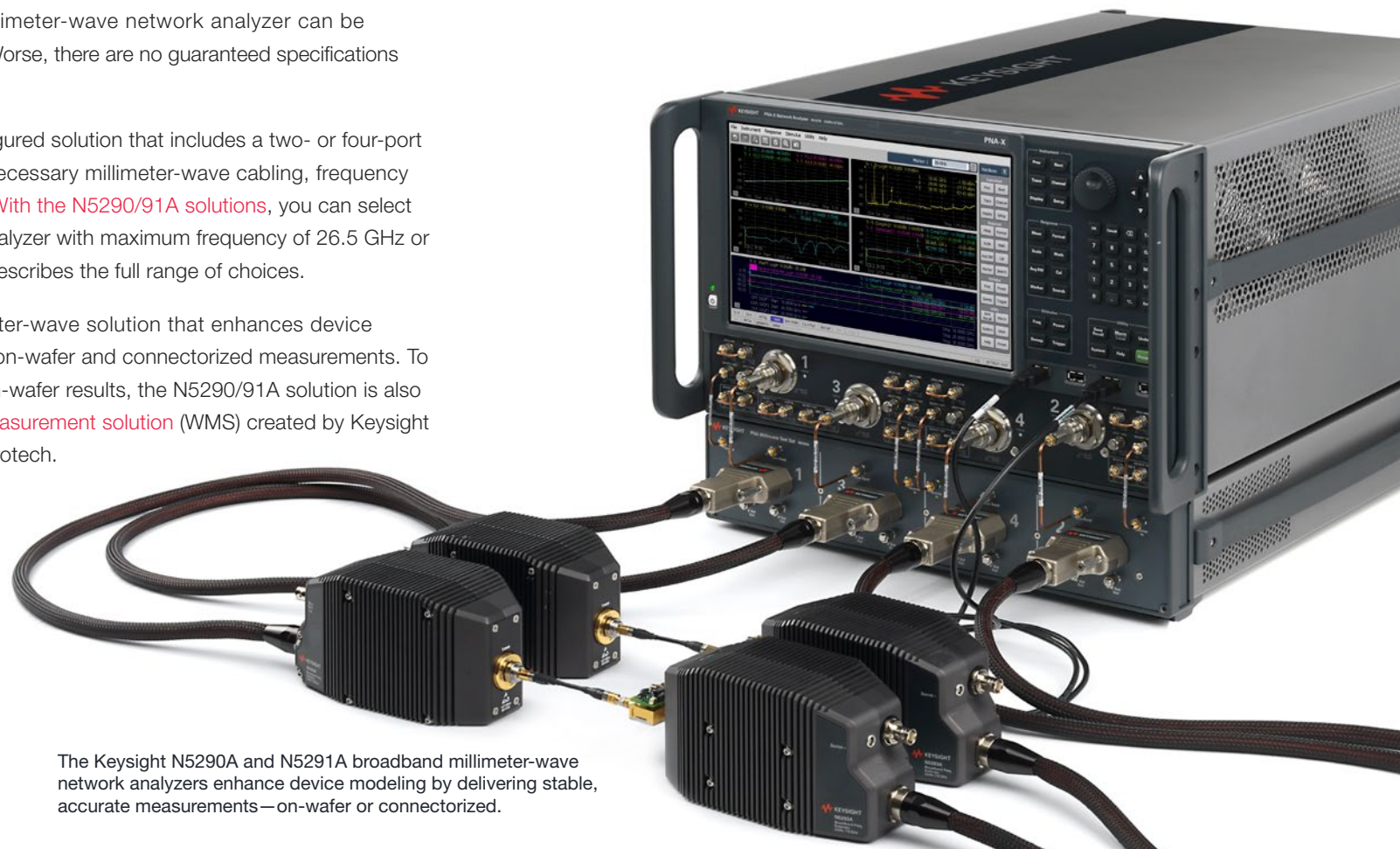

The Keysight N5290A and N5291A broadband millimeter-wave network analyzers enhance device modeling by delivering stable, accurate measurements—on-wafer or connectorized.



HINT 2

Calibrate for Better Accuracy



HINT 2 Calibrate for Better Accuracy

Create Accurate Device Models

Calibration helps you ensure better results across the entire frequency range of your design. That's 900 Hz to 120 GHz with our broadband millimeter-wave network analyzers.

In the N5290/91A, the calibration process uses an improved-accuracy database that supports a **1.0 mm calibration kit** and a **1.0 mm verification kit**. The purpose-built calibration kit and new **DC-to-120 GHz power sensor** provide traceable measurements that reduce uncertainty through accurate characterization of residual calibration errors. In addition, automatic fixture de-embedding and removal ensures greater accuracy in calibration at the probe tips and enhances the accuracy of on-wafer measurements.

The companion **compact frequency-extender modules** include ruggedized 1.0 mm test ports to ensure repeatable connections day after day, measurement to measurement. This reduces calibration uncertainty and further improves your system-level measurement precision.

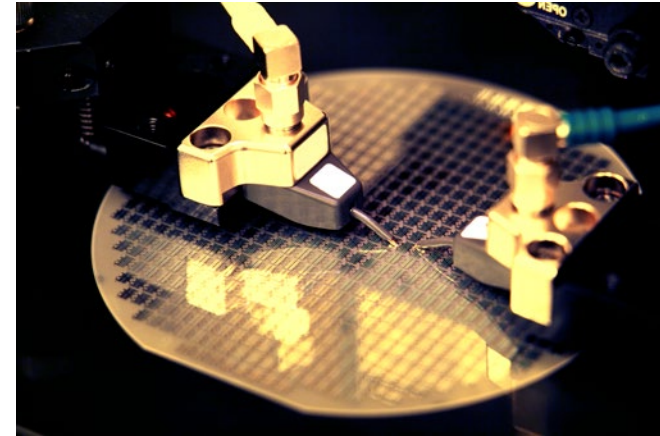

The combination of calibration, fixture de-embedding and fixture removal enhances the accuracy of on-wafer measurements.





HINT 3

Accelerate Complex Test Plans

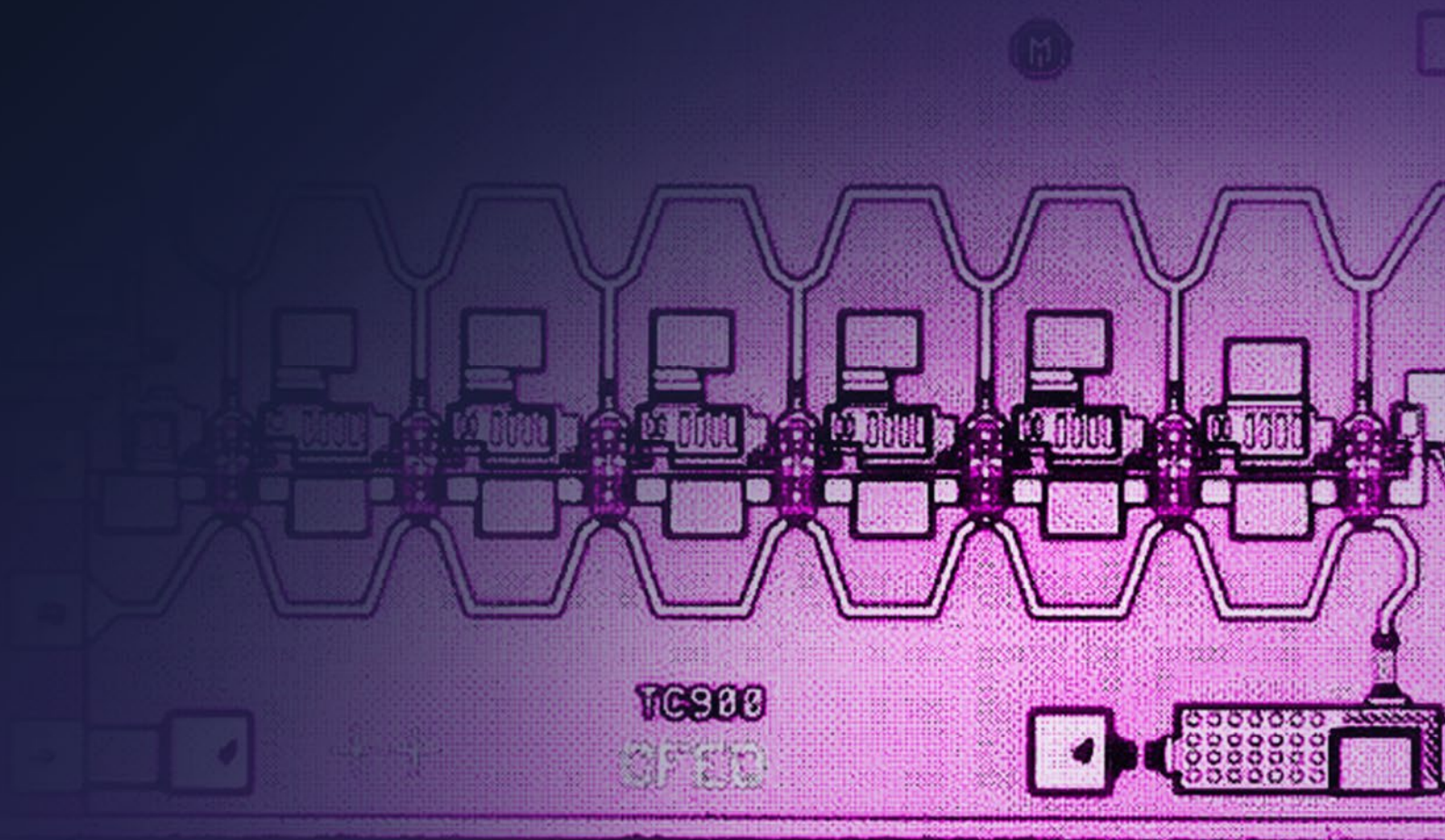

HINT 3

Accelerate Complex Test Plans

Simplify MMIC Testing

New-generation monolithic microwave integrated circuits (MMICs) include components that operate at baseband, RF, microwave and millimeter-wave. A vector network analyzer (VNA) with single-sweep coverage from hertz to gigahertz enables you to test all those components in one test setup.

The need to connect, disconnect and reconnect a MMIC to multiple analyzers is inconvenient and time-consuming. The solution is a VNA that has a **single-connection, multiple-measurement** (SCMM) architecture. In the PNA-X, SCMM lets you measure passive or active devices with one set of connections: S-parameters, noise figure, gain compression, THD, IMD, and spectrum analysis.

Control of source phase and frequency offset simplifies testing of I/Q modulators and converters as well as differential mixers and amplifiers. Precise control of relative phase between sources lets you eliminate hybrid couplers and baluns.

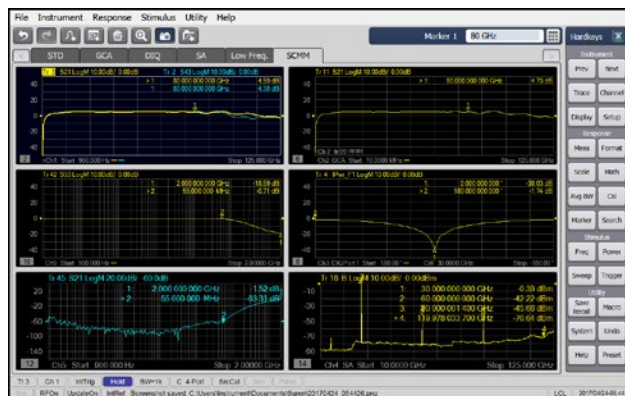

Greater integration inside MMICs and other wideband designs often means testing more functions per device through fewer access points. SCMM is the most convenient and effective solution.

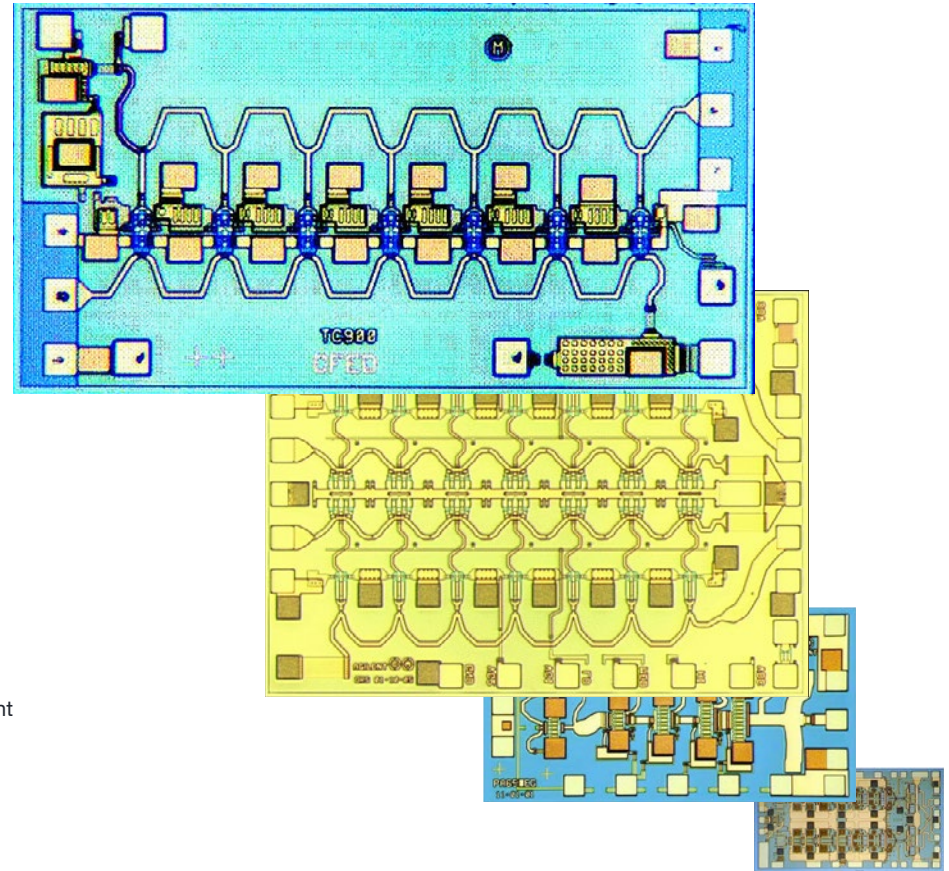



HINT 4

Simplify Measurement Configuration



HINT 4 Simplify Measurement Configuration

Speed Through Complex Tasks With Measurement Applications

To help you save time—and ensure correct configuration of complex tasks—our **network analyzer software tools** will help you achieve deeper insights into device performance:

- **Scalar mixer/converter:** Supports scalar characterization of mixers and frequency converters
- **Gain-compression:** Provides complete characterization of amplifiers and frequency converters
- **Noise-figure:** Enables further characterization of frequency converters
- **Differential and I/Q devices:** Simplifies testing of amplifiers and mixers
- **Spectrum analyzer:** Provides calibrated multi-channel spectrum analysis

These applications are touch-enabled, providing a more intuitive way to investigate, characterize, and troubleshoot broadband millimeter-wave devices.

Another point: transportable software licensing lets you buy one copy of an application and share it between multiple instruments. This maximizes utilization by letting you and your teammates assign needed functionality to a specific instrument, when and where it's needed.

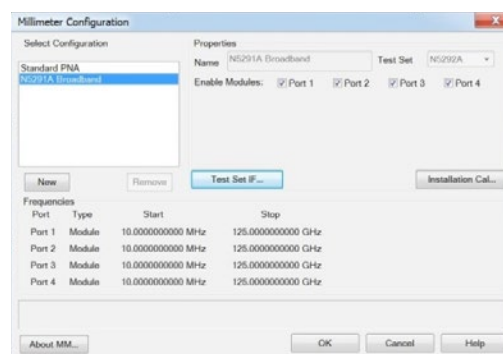
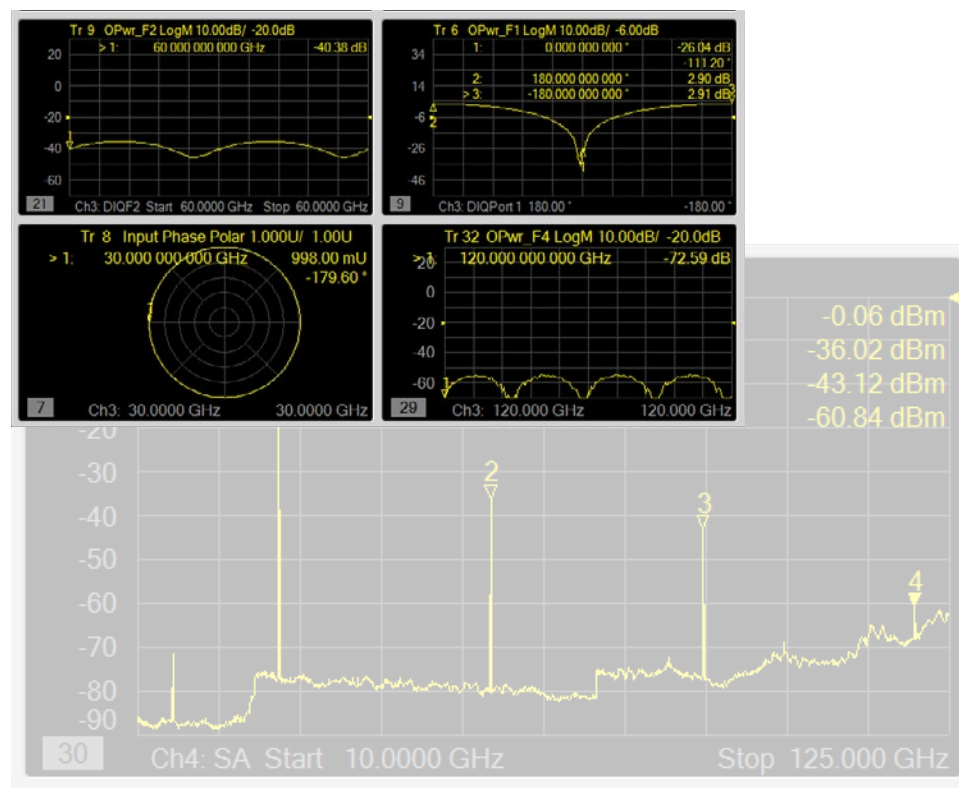

The touch-based interface makes analysis more intuitive, and it includes task-specific screens such as Millimeter Configuration that guide new or infrequent users and help ensure better results.



HINT 5

Reduce Your Total Cost of Test



HINT 5 Reduce Your Total Cost of Test

Utilize Wider Coverage and Multi-setup Calibration

Wider frequency coverage helps reduce the cost of your test solution. For example, a 900 Hz start frequency in a millimeter-wave network analyzer eliminates the need to purchase a dedicated low-frequency VNA. Two more advantages: moving the DUT between fewer test stations increases yield by reducing the likelihood of damage; and using one analyzer reduces complexity by streamlining the development of test system software.

Optimizing the calibration process will further reduce your cost of test. It starts with the ability to maintain a single calibration across multiple setups. This requires exceptional stability in the test system over an extended period of time during the entire test cycle or production run. In the N5290/91A, the “cal all” feature enables you to perform one calibration and apply it to multiple measurement setups.

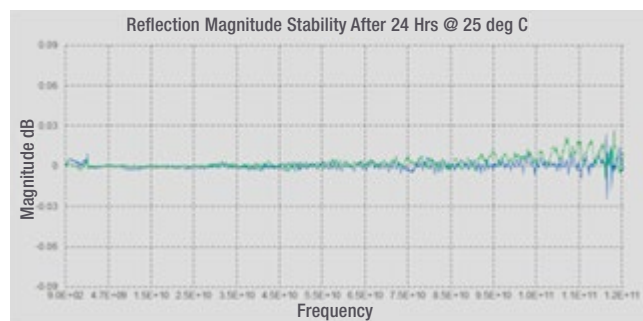

With magnitude stability of less than 0.015 dB, our broadband millimeter-wave network analyzers can use a single calibration for 24 hours while also maintaining measurement uncertainty.



Optimize Device Performance at Millimeter-wave Frequencies

Enhance device modeling with stable, accurate measurements—on-wafer or connectorized—using Keysight's broadband millimeter-wave network analyzers. Core elements are a PNA or PNA-X network analyzer along with compact frequency extenders, a test-set controller, and advanced measurement applications.

With these solutions, you can reach for unrivaled excellence in your measurements and designs up to 120 GHz.



Build Confidence in Millimeter-wave Design and Test

It's easy to underestimate the challenges that arise at these frequencies. That's why Keysight continues to bring you easier access to accurate, repeatable results at everhigher frequencies and wider bandwidths.

Tap into our millimeter-wave expertise and discover innovative tools for design, simulation, test and analysis.

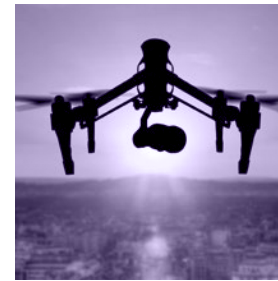

GET THE DETAILS



Network Analyzer: *N5291A 900 Hz to 120 GHz PNA MM-Wave System*

